

DE Funk-Raumbediengerät Touchline
 FR Thermostat Touchline
 EN Wireless room thermostat Touchline
 ES Touchline Termostato ambiente
 DK Touchline Termostat
 SE Touchline Termostat
 NO Touchline Termostat
 FI Touchline Termostaatti
 PL Termostat radiowy Touchline

Kurzbetriebsanleitung
 Mode d'emploi succinct
 Brief operating instructions
 Manual de instrucciones breve
 Kvikmanual
 Snabbguide
 Enkel manual
 Pikaohje
 Instrukcja obsługi

<input type="checkbox"/>	1135006444	17466393.100
<input type="checkbox"/>	IR 1135006446	17466393.120
<input checked="" type="checkbox"/>	1135006447	17466393.102
<input checked="" type="checkbox"/>	IR 1135006449	17466393.122

DE Für den Einsatz in üblicher Umgebung
 FR Pour usage dans un environnement normal
 EN For use in normal environment
 ES Para el uso en ambiente normal
 DK Kan anvendes i normale omgivelser
 SE För placering i normal miljö
 NO Kan brukes i normale omgivelser
 FI Käytetään normaalissa ympäristössä
 PL Zastosowanie w zwykłym otoczeniu

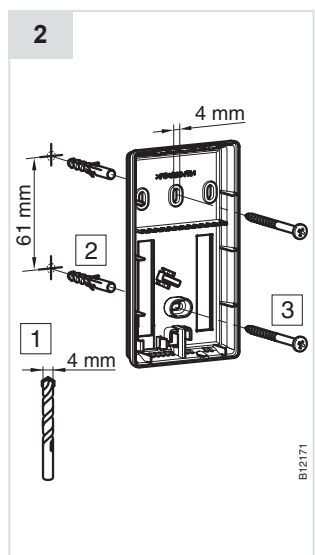
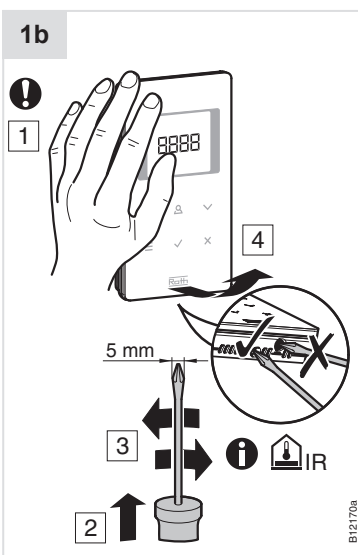
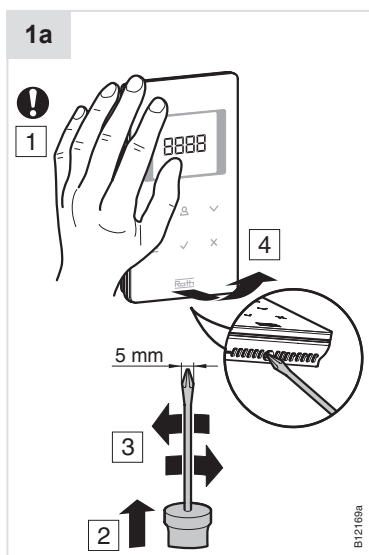
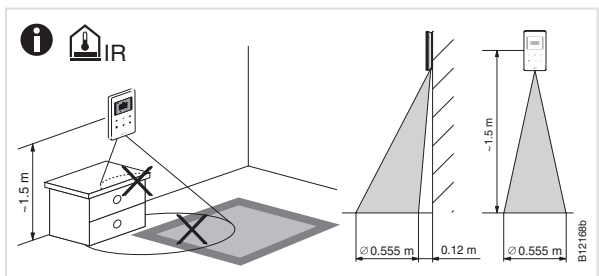
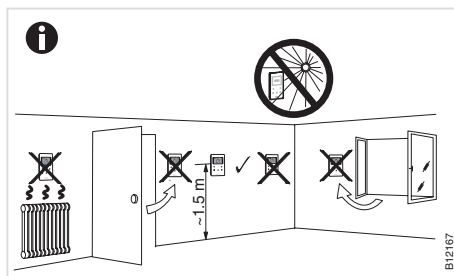
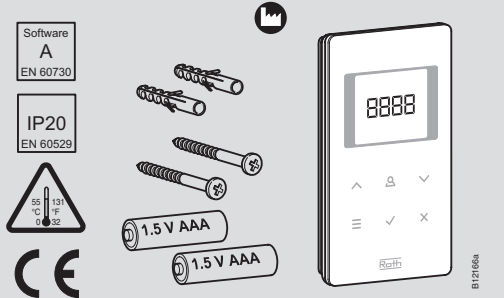

3

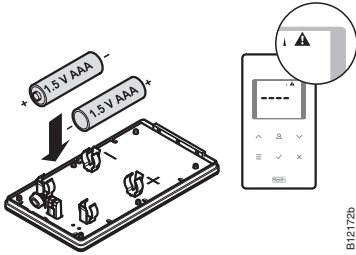

B12172b

4

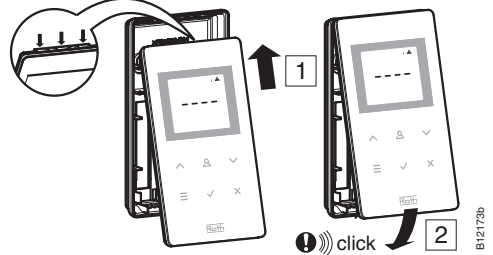

B12173b

5

DE Adressierung Raumbediengerät mit einem Kanal oder mehreren Kanälen
 FR Apprentissage du boîtier d'ambiance avec un canal ou plusieurs canaux
 EN Addressing room operating unit with one channel or multiple channels
 ES Direccionamiento de la unidad de mando con un canal o con varios canales
 DK Tilmelding af rumtermostat til en eller flere kanaler
 SE Adressering av rumstermostat till en eller flera kanaler
 NO nmelding av romtermostat til en eller flere kanaler
 FI Rekisteröi huonetermostaatti yhteen tai useampaan kanavaan
 PL Adresowanie termostatu do kanału lub wielu kanałów



aus
 éteint
 off
 de
 slukket
 från
 slukket
 ei päällä
 wyl



ein
 allumé
 on
 en
 lyser
 till
 lyser
 palaa
 wt



blinkt
 clignote
 blinking
 parpadea
 blinker
 blinkar
 blinker
 vilkkuu
 miga

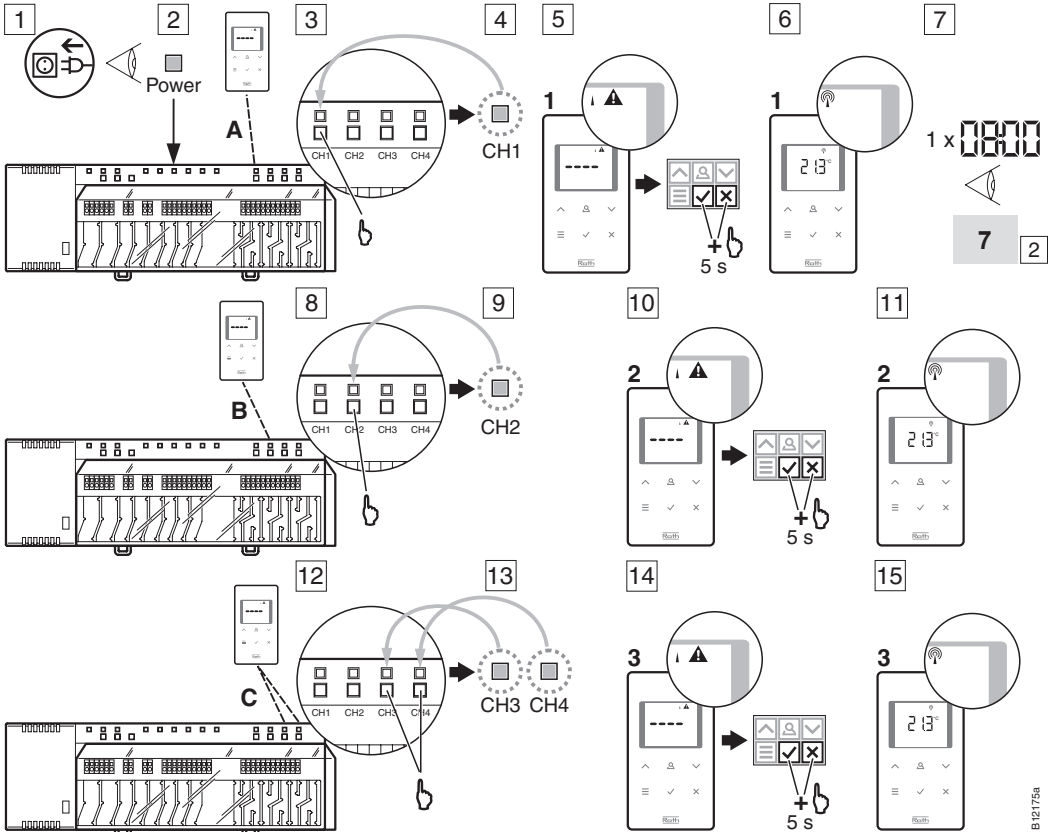

B12175a

6

DE Adressierung testen
FR Tester l'apprentissage
EN Test addressing
ES Probar direccionamiento

DK Test tilmelding (linktest)
SE Adresseringstest
NO Test innmelding (link test)
FI Rekisteröinnin testaus (yhteystesti)
PL Test adresowania

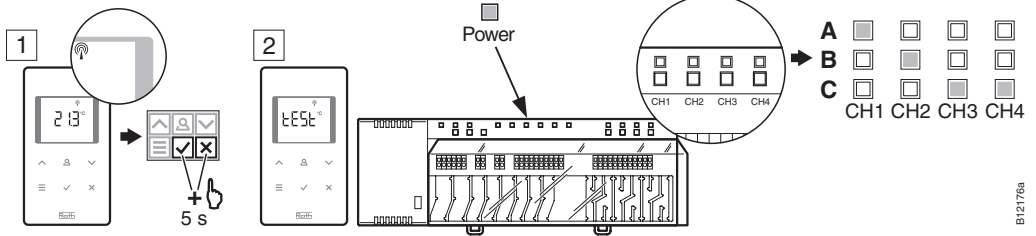

B12176a

i

DE Adressierung löschen
FR Supprimer l'apprentissage
EN Delete addressing
ES Borrarr direccionamiento
DK Slet tilmelding
SE Ta bort adressering
NO Slett innmelding
FI Useampi ohjauksikkö
PL Usuwanie adresowania

<input type="checkbox"/>	<input type="checkbox"/>	<input type="checkbox"/>
aus	blinkt	blinkt schnell
éteint	clignote	clignote rapidement
off	blinking	blinking fast
de	parpadea	parpadea rápidamente
slukket	blinker	blinker hurtigt
från	blinkar	blinkar snabbt
slukket	blinker	blinker raskt
ei päällä	vilkkuu	vilkkuu nopeasti
wył	miga	miga szybko

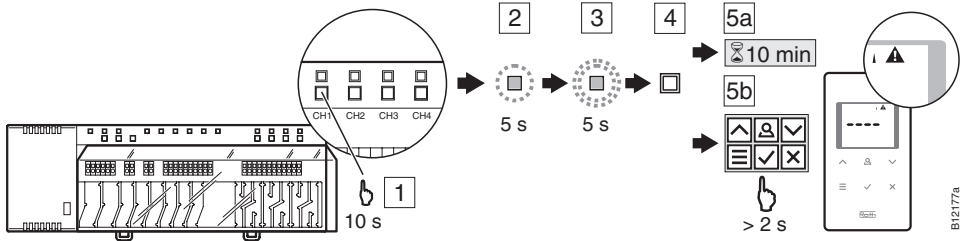

B12177a

7

DE Uhrzeit und Datum einstellen
FR Configurer l'heure et la date
EN Set time and date
ES Ajustar la fecha y hora

DK Indstil tid og dato
SE Ställ in tid och datum
NO Still inn tid og dato
FI Aseta aika ja pvml
PL Ustawianie czasu i daty

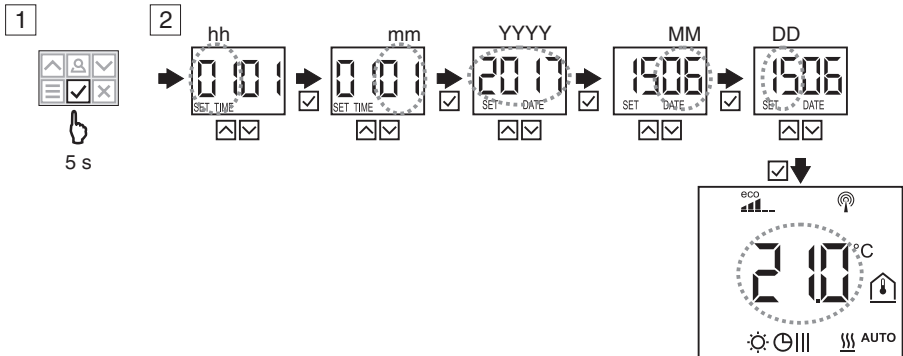

B12178b

DE Bedienung
FR Exploitation
EN Operation
ES Manejo

DK Betjening
SE Drift
NO Betjening
FI Toiminta
PL Obsługa

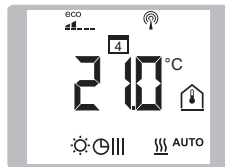
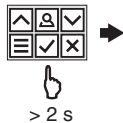
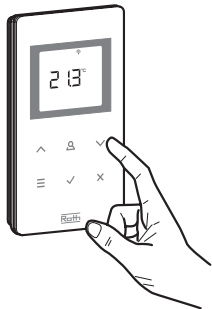

B 12174a

DE Bedienung aktivieren
FR Veille
EN Stand-by to wake-up
ES Stand-by
DK Stand-by visning
SE Standby läge
NO Stand-by visning
FI Valmiustila
PL Aktywacja obsługi

DE Bedienanzeige
FR Indication de service
EN Operating display
ES Indicador
DK Aktiv visning
SE Driftindikering
NO Aktiv visning
FI Näyttö
PL Wskaźniki obsługi

	2 s: 					5 s:	5 s:	
DE	• Bedienung aktivieren (beliebige Taste)	• Menümodus aktivieren • Menüebene wechseln	• Wert ändern	• Speichern • Bestätigen	• Abbrechen	• Adressierung • Testen	• Bedienung verriegeln / entriegeln	• Funktions-taste
FR	• Activer l'exploitation	• Activer le mode menu • Changer de menu	• Modifier la valeur	• Enregistrer • Confirmer	• Annuler	• Adressage • Tester	• Verrouiller / déverrouiller l'exploitation	• Touche de fonction
EN	• Activate operation	• Activate menu mode • Change menu level	• Change value	• Save • Confirm	• Cancel	• Addressing • Test	• Disable / enable operation	• Function button
ES	• Pantalla	• Activar el modo de menú • Cambiar de nivel de menú	• Modificar valor	• Guardar • Confirmar	• Cancelar	• Direccio namiento • Probar	• Bloquear / Desbloquear unidad de mando	• Tecla de función
DK	• Aktiver betjening (tryk på en vilkårlig tast)	• Aktiver menu • Skift menu	• Ændre værdi	• Gem værdi • Bekræft OK	• Annuller	• Tilmelding • Linktest	• Tastatur lås / lås op	• Funktionstast
SE	• Aktivera meny (tryck på valfri knapp)	• Aktivera meny • Ändra meny	• Ändra värde	• Spara värde • Bekräfta OK	• Ta bort	• Adressering • Test	• Meny Lås / lås upp	• Funktions-tagenter
NO	• Aktiver betjening (trykk vilkårlig tast)	• Aktiver meny • Skift meny	• Endre verdi	• Lagre verdi • Bekreft OK	• Annuller	• Innmelding • Link test	• Tastatur lås / lås opp	• Funksjons-tast
FI	• Aktivoi toiminta (Paina mitä tahansa näppäintä)	• Aktivoi valikko • Vaihda valikko	• Muuta arvo	• Tallenna • Vahvista	• Peruuta	• Rekisteröinti • Testi	• Lukitus / avaus	• Funktio-näppäintä
PL	• Aktywacja obsługi (dowolny przycisk)	• Aktywacja menu • Przewijanie menu	• Zmiana wartości	• Zapisywanie • Zatwierdzenie	• Odrzucanie	• Adresowanie • Test	• Obsługa blokowanie / Odblo-kowywanie	• Przyciski funkcyjne

	DE	FR	EN	ES
	Batterie fast leer	Batterie presque vide	Battery nearly empty	La batería está casi agotada
	Relativer Energieverbrauch	Consommation d'énergie relative	Relative energy consumption	Consumo de energía relativo
 1)	Taupunktalarm	Alarme de point de rosée	Dewpoint alarm	Alarma de punto de condensación
	Funksignal	Signal radio	Wireless signal	Radioseñal
	Funkverbindung verloren	Connexion radio perdue	Loss of wireless connection	Se ha perdido la radiocomunicación
	Genereller Alarm	Alarme générale	General alarm	Alarma general
	Bedienung verriegelt	Exploitation verrouillée	Operation disabled	Unidad de mando bloqueada
	Arbeitstage	Jours de travail	Weekdays	Días laborables
	Wochenende	Fin de semaine	Weekend	Fines de semana
	Uhrzeit und Datum/ Zeitprogramm	Heure et date/ Programme horaire	Time and date/ Time programme	Fecha y hora
 23 °C	Aktuelle Temperatur	Température actuelle	Current temperature	Temperatura actual
	Raumtemperatur	Température ambiante	Room temperature	Temperatura ambiente
 2)	Fußbodentemperatur	Température du sol	Floor temperature	Temperatura del suelo
	Aus (Frostschutz)	Arrêt (protection antigel)	Off (frost protection)	Desconectado (protección antiheladas)
	Reduzierter Betrieb	Mode réduit	Reduced mode	Régimen reducido
	Normaler Betrieb	Mode normal	Normal mode	Régimen normal
	Zeitprogramm	Programme horaire	Time programme	Programa temporizador
	Zeitprogramm mit externer Uhr	Programme horaire avec horloge externe	Time programme with external clock	Programa temporizador con reloj externo
	Kühlmodus	Mode de refroidissement	Cooling mode	Modo de refrigeración
	Kühlsperre	Blocage du refroidissement	Disable cooling	Bloqueo de refrigeración
	Heizmodus	Mode de chauffage	Heating mode	Modo calefactor
AUTO	Auto-Heiz- und Kühlmodus	Mode de chauffage et refroidissement automatique	Auto heating and cooling mode	Modo automático calefactor y de refrigeración
	1) nur mit Zubehör 2) IR Typ	1) seulement avec accessoire 2) Type IR	1) with accessories only 2) IR type	1) sólo con accesorios 2) Tupo IR

	DK	SE	NO	FI	PL
	Batteri næsten tomt	Batteri nästan slut	Batteri snart tomt	Heikko paristo	Bateria prawie pusta
	Relativt energiforbrug	Aktuell energiförbrukning	Relativt energi forbruk	Suhteellinen energian käyttö	Stosunkowe zużycie prądu
	Duggpunkts alarm	Fuktlarm	Duggpunkts alarm	Kastepiste hälytys	Alarm punktu rosy
	Trådløst signal	Trådlös signal	Trådløst signal	Langaton signaali	Sygnal radiowy
	Forbindelse mistet	Ingen trådlös signal	Forbindelse mistet	Ei signaalia	Utrata sygnału radiowego
	Generel alarm	Generellt larm	Generell alarm	Yleinen hälytys	Alarm ogólny
	Tastatur låst	Drift låst	Tastatur låst	Toiminta lukittu	Blokada obsługi
	Arbejdsdage	Arbetsdagar	Ukedager	Arkipäivät	Dni robocze
	Weekend	Veckoslut	Weekend	Viikonloppu	Weekend
	Tid og dato/tidsprogram	Tid och datum/ tidsprogram	Tid og dato/tidsprogram	Aika ja päivämäärä/ ohjelma	Czas i data/ Programy czasowe
	Aktuel temperatur	Aktuell temperatur	Aktuell temperatur	Lämpötila	Aktualna temperatura
	Rumtemperatur	Rumstemperatur	Romtemperatur	Huonelämpötila	Temperatura pomieszczenia
	Gulvtemperatur	Golvtemperatur	Gulvtemperatur	Lattialämpötila	Temperatura podłogi
	Slukket (frostbeskyttelse)	Från(frysskydd)	Av (frostsikring)	Suljettu (pakkasuoja)	Wył (ochrona przed mrozem)
	Reduceret temperatur	Sänkt temperatur	Senket temperatur	Alennettu lämpötila	Tryb nocny
	Normal temperatur	Normal temperatur	Normal temperatur	Normaali lämpötila	Tryb dzienny
	Tidsprogram	Tidsprogram	Tidsprogram	Aika ohjelma	Program czasowy
	Tidsprogram med eksternt ur	Tidsprogram med eksternt ur	Tidsprogram med eksternt ur	Kello ohjaus	Program czasowy z zewnętrznym zegarem
	Køle mode	Kyldrift	Kjøle modus	Viilennystila	Tryb chłodzenia
	Køle spærre	Kylspärr	Kjøling slått av	Viilennys pois päältä	Blokada chłodzenia
	Varme mode	Värmedrift	Varme modus	Lämmitystila	Tryb grzania
AUTO	Auto varme og køle mode	Auto värme/kyla	Auto varme og kjøle modus	Automaattinen lämmitys/viilennys tila	Auto-grzanie i chłodzenie
	1) kun med tilbehør 2) IR type	1) bara med tillbehör 2) IR typ	1) kun med tilbehør 2) IR type	1) lisävarusteella 2) IP malli	1) Tylko z osprzętem 2) Model IR

DE Sollwert einstellen
 FR Configurer la valeur de consigne
 EN Set setpoint
 ES Ajustar el valor nominal

DK Indstil ønsket temperatur
 SE Ställ in önskad temperatur
 NO Still inn ønsket temperatur
 FI Aseta haluttu lämpötila
 PL Ustawianie wartości

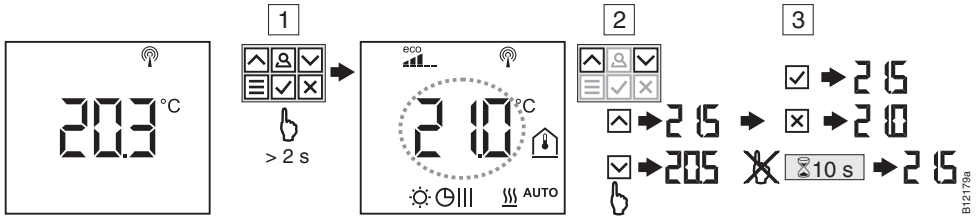

DE Fußbodentemperatur einstellen
 FR Configurer la température du sol
 EN Set floor temperature
 ES Ajustar la temperatura del suelo

DK Indstil gulvtemperatur
 SE Ställ in golvtemperatur
 NO Still inn gulvtemperatur
 FI Aseta lattialämpötila
 PL Ustawianie temperatury podłogi

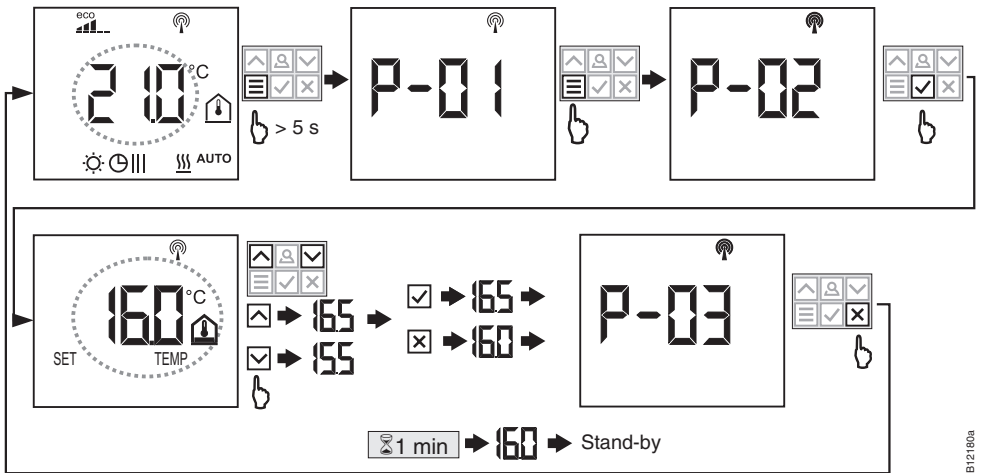



- DE Bedienung verriegeln
- FR Verrouiller l'exploitation
- EN Disable operation
- ES Bloquear la unidad de mando
- DK Lås tastatur
- SE Lås meny
- NO Lås tastatur
- FI Lukitse
- PL Blokada obsługi

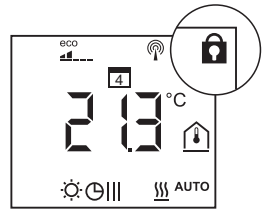

- DE Bedienung entriegeln
- FR Déverrouiller l'exploitation
- EN Enable operation
- ES Desbloquear la unidad de mando
- DK Lås tastatur op
- SE Öppna meny
- NO Lås opp tastatur
- FI Avaa
- PL Odblokowywanie obsługi

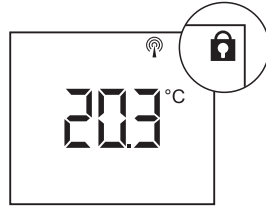

B12181a

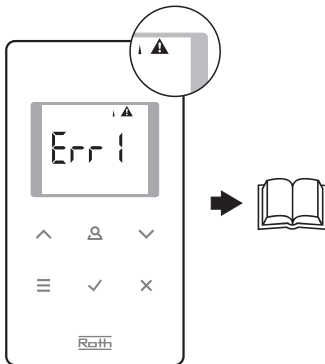

B12182a

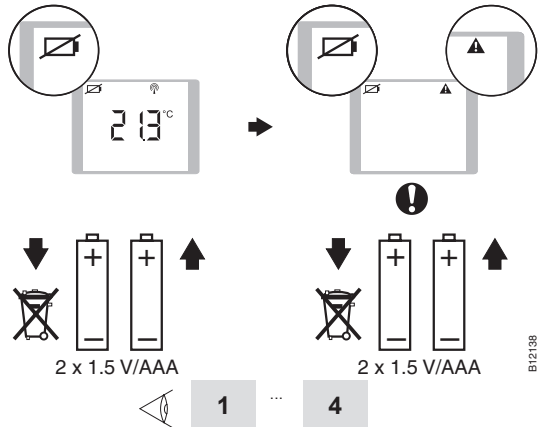

2 x 1.5 V/AAA

2 x 1.5 V/AAA

B12138



Scan the code for complete
product information

- DE Dokument aufbewahren
- EN Retain this document
- FR Ce document est à conserver
- ES Guardar el documento
- DK Opbevar dette dokument
- SE Spara dokumentationen
- NO Oppbevar dette dokument
- FI Säilytä tämä opas
- PL Zachować instrukcję

- Roth Werke GmbH
- Roth UK Ltd.
- Roth France S.A.S
- Global Plastic S.A.
- Roth Danmark A/S.
- Roth Sverige AB
- Roth Norge AS
- Roth Finland Oy
- Roth Polska Sp. z o.o.

- 35232 Dautphetal
- Worcester, WR4 9FA
- 77465 Lagny sur Marne Cedex
- 31500 Tudela (Navarra)
- 3600 Frederikssund
- 212 39 Malmö
- 1396 Billingstad
- 10300 Karjaa
- 65785 Zielona Góra

- +49 (0) 6466/922-0
- +44 (0) 1905/453424
- +33 (0) 1/64124444
- +34 948/844406
- +45 47 38 01 21
- +46 40 53 40 90
- +47 67 57 54 00
- +358 19 440330
- +48 68 3202072

- www.roth-werke.de
- www.roth-uk.com
- www.roth-france.fr
- www.roth-spain.com
- www.roth-danmark.dk
- www.roth-sverige.se
- www.roth-norge.no
- www.roth-finland.fi
- www.roth-polska.com

04/2019